

## Diaphragm Accumulators



### 1. DESCRIPTION

#### 1.1. FUNCTION

Fluids are practically incompressible and cannot therefore store pressure energy.

The compressibility of a gas is utilised in hydraulic accumulators for storing fluids. HYDAC diaphragm accumulators are based on this principle, using nitrogen as the compressible medium.

A diaphragm accumulator consists of a fluid section and a gas section with the diaphragm acting as the gas-proof screen.

The fluid section is connected to the hydraulic circuit so that the diaphragm accumulator draws in fluid when the pressure increases and the gas is compressed. When the pressure drops, the compressed gas expands and forces the stored fluid into the circuit.

At the base of the diaphragm is a valve poppet. This shuts off the hydraulic outlet when the accumulator is completely empty and thus prevents damage to the diaphragm.

#### NOTE:

HYDAC diaphragm accumulators when fitted with a HYDAC Safety and Shut-off Block comply with the regulations of the Pressure Equipment Directive PED 97/23/EC and the German regulations on health & safety at work (Betr.Sich.V.).

See catalogue section:

- Safety and shut-off block SAF/DSV No. 3.551

#### 1.2. DESIGN

HYDAC diaphragm accumulators are available in two versions.

##### 1.2.1 Weld type

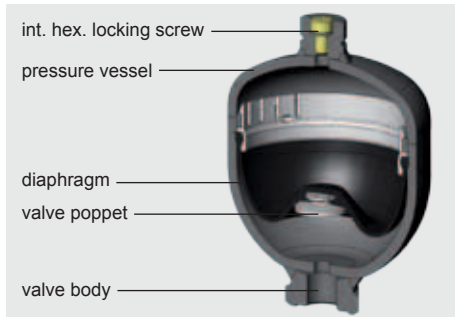

This consists of:

- Welded pressure vessel, rechargeable on the gas side or, alternatively, completely sealed. Fluid connection available in various types.
- Flexible diaphragm to separate the fluid and gas sections.
- Valve poppet set into the base of the diaphragm.

##### 1.2.2 Screw type

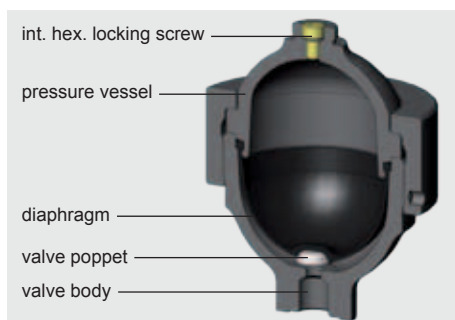

This consists of:

- Forged upper section with gas charging connection.
- Forged lower section with fluid connection.
- Exchangeable flexible diaphragm to separate the gas and fluid.
- Vulcanized valve poppet set into the base of the diaphragm.
- Lock nut to hold the upper and lower sections of the accumulator together.

##### 1.2.3 Diaphragm materials

The diaphragms are available in the following elastomers:

- NBR (acrylonitrile butadiene rubber, perbunan),
- IIR (butyl rubber),
- FKM (fluoro rubber, Viton®),
- ECO (ethylene oxide epichlorohydrin rubber).

The material must be selected according to the particular operating fluid and temperature.

When choosing the elastomer, allowances must be made for the fact that the gas can cool down to below the permitted elastomer temperature if there are adverse discharge conditions (high pressure ratio  $p_2/p_0$ , high discharging velocity). This can cause cold cracking in the elastomer. The gas temperature can be calculated using the HYDAC Accumulator Simulation Program ASP.

##### 1.2.4 Corrosion protection

For use with chemically aggressive fluids the accumulator can be supplied with corrosion protection, such as plastic coating or a galvanic or chemical surface protection. If this is insufficient, then almost all types can be supplied in stainless steel.

### 1.3. MOUNTING POSITION

Optional. However, if there is a risk of contamination collecting, a vertical position is preferable (fluid connection at the bottom).

## 1.4. TYPE OF MOUNTING

Accumulators up to 2 l can be screwed directly inline.

Where strong vibrations are expected, the accumulator must be secured to prevent it working loose. For weld type accumulators we recommend HYDAC support clamps.

For screw type accumulators with lock nut, a suitable support console can be ordered.

Additional male threads on the hydraulic connection are available for screwing into mounting holes - see table 3.1.

See catalogue section:

- Supports for Hydraulic Accumulators No. 3.502

## 1.5. GENERAL

### 1.5.1 Permitted operating pressure

See tables 3.1. and 3.2.

The permitted operating pressure can differ from the nominal pressure for foreign test certificates.

### 1.5.2 Nominal volume

See tables 3.1. and 3.2.

### 1.5.3 Effective gas volume

Corresponds to the nominal volume of the diaphragm accumulator.

### 1.5.4 Effective volume

Volume of fluid which is available between the operating pressures  $p_2$  and  $p_1$ .

### 1.5.5 Fluids

Mineral oils, hydraulic oils. Other fluids on request.

### 1.5.6 Gas charging

All accumulators are supplied with a protective pre-charge.

Higher gas pre-charge pressures are available on request (gas charging screw or sealed gas connection).

Hydraulic accumulators must only be charged with nitrogen.

Never use other gases.

**RISK OF EXPLOSION!**

### 1.5.7 Permitted operating temperature

-10 °C ... +80 °C

263 K ... 353 K

for material code 112.

Others on request

### 1.5.8 Permitted pressure ratio

Ratio of maximum operating pressure  $p_2$  to gas pre-charge pressure  $p_0$ .

### 1.5.9 Max. flow rate of operating fluid

In order to achieve the max. flow rate given in the tables, a residual fluid volume of approx. 10 % of the effective gas volume must remain in the accumulator.

### 1.5.10 Certificate codes

Hydraulic accumulators which are installed in countries outside Germany are supplied with the test certificates required in that country. The country of installation must be stated at the time of ordering.

HYDAC pressure vessels can be supplied with virtually any test certificate.

Please note that the operating pressure can differ from the nominal pressure.

The following table contains a few examples of the codes used in the model code for different countries of installation:

Australia	F <sup>1)</sup>
Brazil	U <sup>3)</sup>
Canada	S1 <sup>2)</sup>
China	A9
CIS	A6
EU member states	U
India	U <sup>3)</sup>
Japan	P
New Zealand	T
South Africa	U <sup>3)</sup>
Switzerland	U <sup>3)</sup>
Ukraine	A10
USA	S
others on request	

<sup>1)</sup> approval required in the individual territories

<sup>2)</sup> approval required in the individual provinces

<sup>3)</sup> alternative certificates possible

On no account must any welding, soldering or mechanical work be carried out on the accumulator shell. After the hydraulic line has been connected it must be completely vented. Work on systems incorporating hydraulic accumulators (repairs, connecting pressure gauges etc.) must only be carried out once the pressure and the fluid have been released.

**Please read the Operating Manual!  
No. 3.100 CE**

#### Note:

Application examples, accumulator sizing and extracts from approvals regulations on hydraulic accumulators can be found in the catalogue section:

- Accumulators No. 3.000

## 2. TECHNICAL SPECIFICATIONS

### 2.1. MODEL CODE

(also order example)

**SBO210 - 2 E1 / 112 U - 210 AK 050**

Series \_\_\_\_\_

Nominal volume [l] \_\_\_\_\_

Type <sup>2)</sup> \_\_\_\_\_

#### Weld type:

- E1 = rechargeable M28x1.5
- E2 = sealed gas connection,  
with gas pre-charge as requested <sup>4)</sup>
- E3 = rechargeable,  
gas valve M16x1.5 / M14x1.5

#### Screw type

- A6 = rechargeable M28x1.5,  
exchangeable diaphragm
- A3 = gas valve M16x1.5 / M14x1.5,  
exchangeable diaphragm

Material code <sup>2)</sup> \_\_\_\_\_

depends on operating medium  
Standard model = 112 for mineral oils

#### Fluid connection

- 1 = carbon steel
- 3 = stainless steel 1.4571
- 4 = carbon steel with protective coating <sup>1)</sup>
- 6 = low temperature steel

#### Accumulator shell

- 0 = plastic coated
- 1 = carbon steel
- 2 = carbon steel with protective coating <sup>1)3)</sup>
- 4 = stainless steel 1.4571
- 6 = low temperature steel

#### Diaphragm

- 2 = NBR20 (acrylonitrile butadiene)
- 3 = ECO (ethylene oxide epichlorohydrin)
- 4 = IIR (butyl)
- 5 = NBR21 (low temperature NBR)
- 6 = FKM (fluoro rubber)
- 7 = other (e.g. PTFE, EPDM ... on request)

Certificate code <sup>2)</sup> \_\_\_\_\_

U = PED 97/23/EC  
For other countries see table

Permitted operating pressure [bar] \_\_\_\_\_

Fluid connection <sup>2)</sup> form \_\_\_\_\_

Standard connection = AK or AB

e.g. Form AK = G 3/4  
for SBO210-2 see Point 3

Pre-charge pressure  $p_0$  [bar] at 20 °C, must be stated clearly, if required! <sup>4)</sup> \_\_\_\_\_

<sup>1)</sup> only for screw type

<sup>2)</sup> not all combinations are possible





<sup>3)</sup> only parts in contact with the medium

<sup>4)</sup> only for type E1 or E2, for scheduled orders

### 3. TECHNICAL SPECIFICATIONS

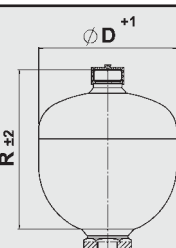
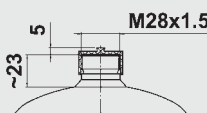
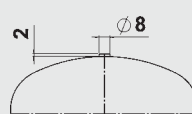
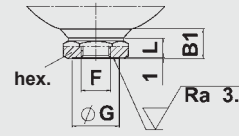
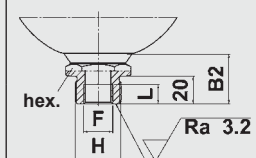
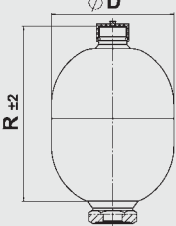
#### 3.1. WELD TYPE ACCUMULATORS – non-exchangeable diaphragms –

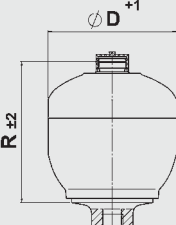
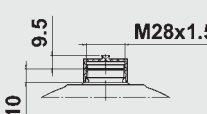
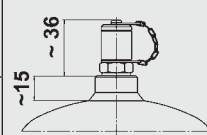
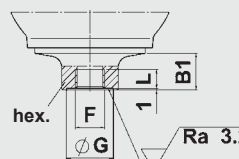
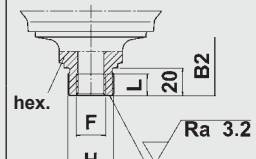
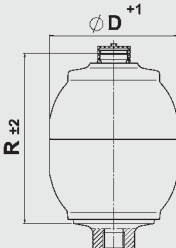
##### 3.1.1 Drawings

Diag.	Type	Gas side connection			Fluid side connection*	
		E1	E2	E3	AK	AB
1						
2			—			
3			on request			
4			—			

\* = alternative fluid connections on request

### 3.1.2 Dimensions

Nom. vol. <sup>1)</sup>	Perm. press. ratio	Series	Certificate code U		R	ØD	Weight	Q <sup>2)</sup>	Standard fluid connection											Diag.
			Permitt. oper. pressure [bar]						Form AK					Form AB						
			Carbon steel	Stainless steel					F	ISO 228	ØG [mm]	L [mm]	B 1 [mm]	hex. SW	F	ISO 228	H DIN 13	L [mm]	B 2 [mm]	
0.075	8 : 1	250	250	–	91	64	0.7	38	G 1/2	–	14	21	30	not available					1	
0.16	8 : 1	210	210	180	103	74	0.8	38	G 1/2	–	14	21	30	not available					1	
		300	300	–	108	78	1.1													
0.32	8 : 1	210	210	160	116	93	1.3	95	G 1/2	–	14	21	30	not available					1	
		300	300	–	120	96	1.8													
0.5	8 : 1	160	160	–	130	102	1.3	95	G 1/2	–	14	21	30	G 1/2	M33x1.5	14	37	41	1	
		210	210	–	133	105	1.7													
0.6	8 : 1	330	330	–	151	115	3.3	95	G 1/2	34	14	21	41	G 1/2	M33x1.5	14	37	41	1	
		350	350	–	130	121	3.5													
0.7	8 : 1	100	100	–	151	106	1.8	95	G 1/2	34	14	21	41	G 1/2	M33x1.5	14	37	41	1	
		140	140	–	142	116	1.8													
0.75	8 : 1	210	210	140	147	121	2.8	95	G 1/2	34	14	21	41	G 1/2	M33x1.5	14	37	41	1	
		250	250	–	152	126	3.6													
		330	330	–	140	126	4.0					26	15			42				
		330	330	–	140	126	4.0													
1	8 : 1	200	200	–	159	136	3.6	95	G 1/2	34	14	21	41	G 1/2	M33x1.5	14	37	41	1	
		250	250	–	192	126	4.4													
1.4	8 : 1	140	140	–	173	145	3.9	95	G 1/2	34	14	21	41	G 1/2	M33x1.5	14	37	41	1	
		210	210	–	178	150	5.4													
		250	250	–	185	153	5.9					33	15			42				
		330	330	–	172	155	7.6													
2	8 : 1	100	100	100	190	160	4.0	150	G 3/4	44	16	28	46	G 3/4	M45x1.5	16	33	46	1	
		210	210	–	198	167	6.6													
	250	250	–	232	153	7.4	43					16	42							
	330	330	–	181	172	9.2														
2.8	4 : 1	210	210	–	250	167	8.2	150	G 3/4	44	16	28	46	G 3/4	M45x1.5	16	33	46	2	
		250	250	–	250	170	7.8													
	6 : 1	330	330	–	237	172	11.0					43	16			42				
		330	330	–	231	172	11.0													
3.5	4 : 1	250	210	–	306	170	11.2	150	G 3/4	44	16	28	46	G 3/4	M45x1.5	16	33	46	2	
		330	330	–	274	172	13.8													
4	4 : 1	50	–	50	294	158	5.0	150	G 3/4	44	16	44	46	G 3/4	M45x1.5	16	33	46	2	
		250	–	180	306	170	11.2													

<sup>1)</sup>Others on request

<sup>2)</sup>Max. flow rate of operating fluid

## 3.2. SCREW TYPE – exchangeable diaphragm –

### 3.2.1 Drawings

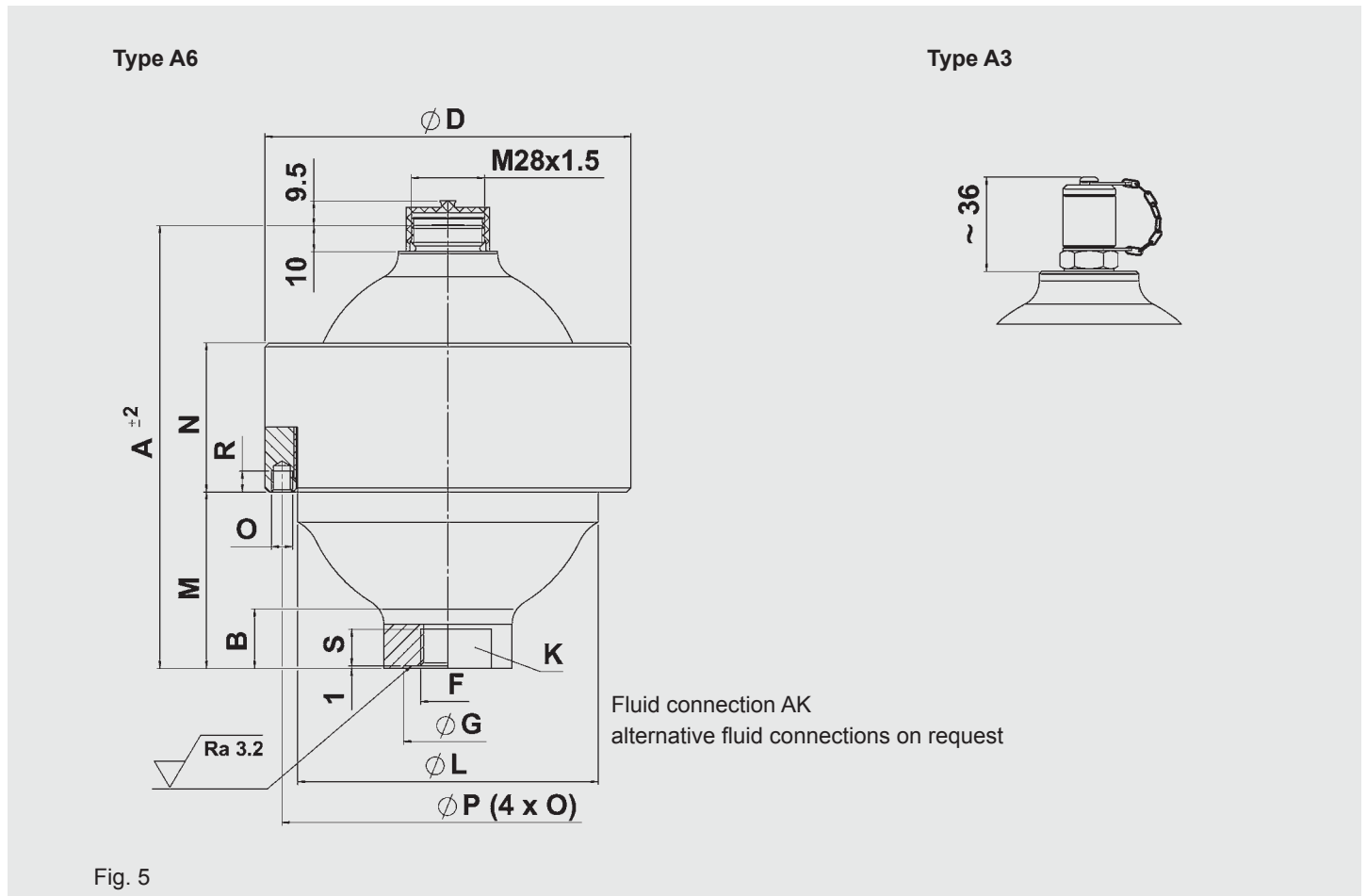

### 3.2.2 Dimensions

Nom. vol. <sup>1)</sup> [l]	Perm. press. ratio $p_2 : p_0$	Series	Certificate code U		Weight [kg]	A [mm]	B [mm]	$\varnothing D$ [mm]	$\varnothing L$ [mm]	M [mm]	N [mm]	O	$\varnothing P$ [mm]	R [mm]	Q <sup>2)</sup> [l/min]	Standard fluid connection				Diag.
			Permitt. oper. pressure [bar]													Form AK				
			Carbon steel	Stainless steel												F ISO 228	S [mm]	$\varnothing G$ [mm]	K SW	
0.1	10 : 1	500	500	–	1.9	110	30	95	–	53	35	–	–	–	95	G 1/2	14	–	36	5
0.25	10 : 1	500	500	–	3.9	129	20	115	92	56	60	–	–	–	95	G 1/2	14	–	36	
			–	350	4.9			125										27		
0.6	10 : 1	450	450	250	5.7	170	19	140	115	68	57	–	–	–	95	G 1/2	14	34	41	
1.3	10 : 1	400	400	–	11.2	212	28	199	160	97	65	M8	180	10	150	G 3/4	16	44	50	
2	10 : 1	250	250	180	11.4	227	17	201	168	101	64	M8	188	10	150	G 3/4	16	44	50	
2.8	10 : 1	400	400	–	22.0	257	30	252	207	106	80	M8	230	10	150	G 3/4	16	44	50	
4	10 : 1	400	400	–	34.0	284	30	287	236	127.5	90	M8	265	10	150	G 3/4	16	44	50	

<sup>1)</sup> Others on request

<sup>2)</sup> Max. flow rate of operating fluid

## 4. NOTE

The information in this brochure relates to the operating conditions and applications described. For applications and operating conditions not described, please contact the relevant technical department. Subject to technical modifications.

**HYDAC Technology GmbH**  
Industriegebiet  
**66280 Sulzbach/Saar, Germany**  
Tel.: +49 (0) 68 97 / 509 - 01  
Fax: +49 (0) 68 97 / 509 - 464  
Internet: www.hydac.com  
E-Mail: speichertechnik@hydac.com